

2020

KOMPONENTER



FUNKI

Gældende fra 1. juni 2020









www.acofunki.dk

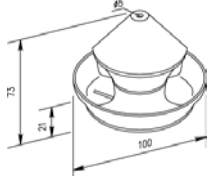
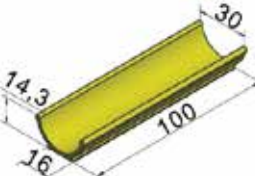

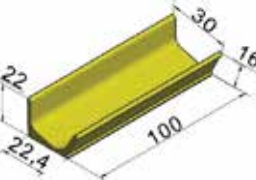

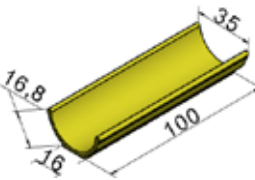
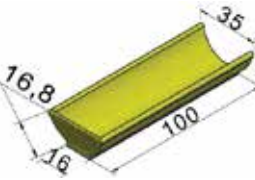
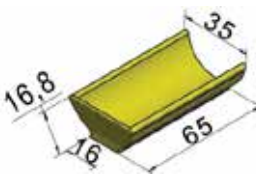

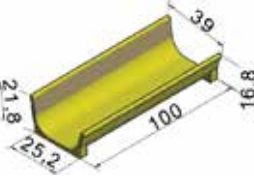
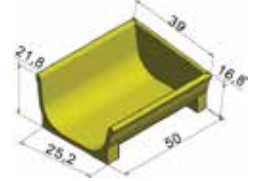
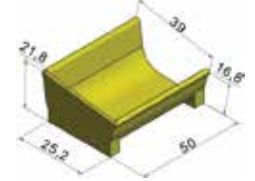



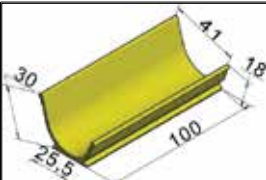
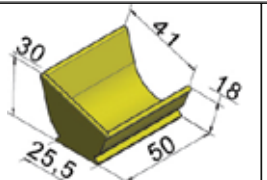
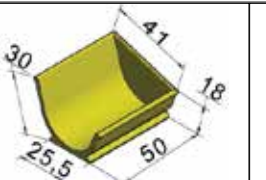

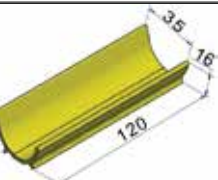
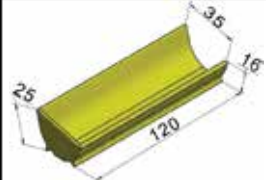
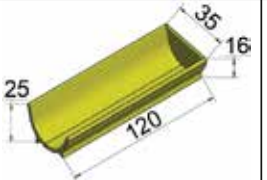

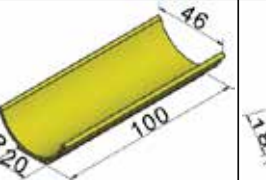
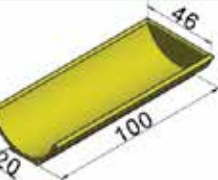
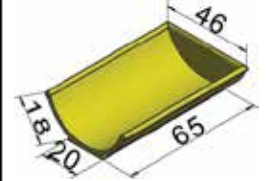
INDHOLDSFORTEGNELSE

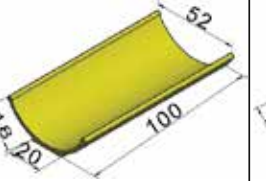
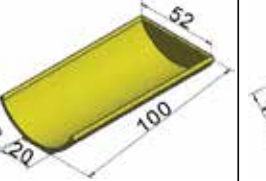
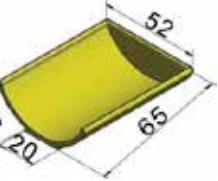

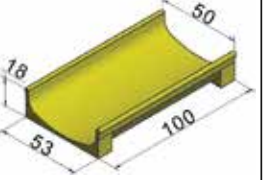
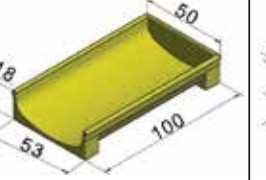
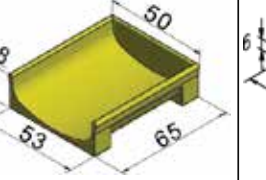
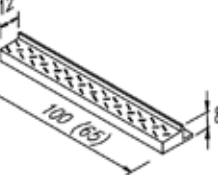
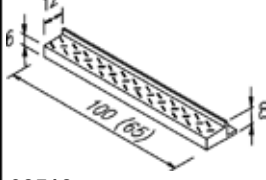
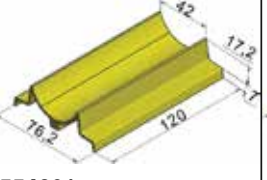
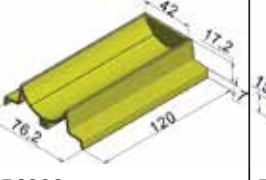
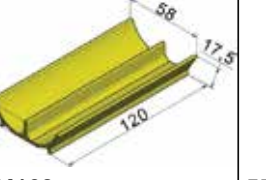



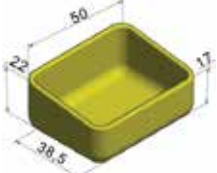
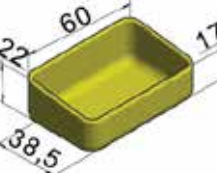
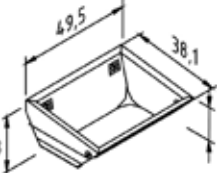
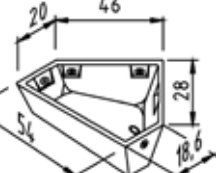
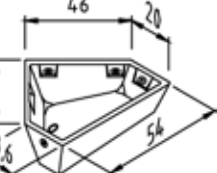
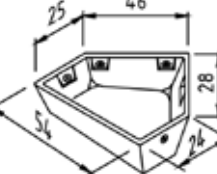
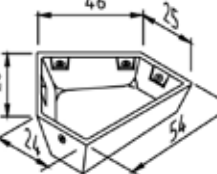

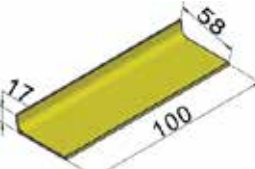

POLYMERKRYBBER TIL GRISE	3
POLYMERKRYBBER TIL KVÆG	6
RUSTFRI KRYBBER	6
TILBEHØR TIL KRYBBER	6
SKÅLE OG DRIKKEKOPPER	7
MASTER FLOW OG AQUA DROP II	9
KOMBIRISTE - PLASTRISTE	11
KOMBIRISTE - STØBEJERSRISTE	14
KOMBIRISTE - TILBEHØR	15
BÆRING	16
VARMEPLADESYSTEMER	18
GUMMIMÅTTER	19
SELVBÆRENDE STØBEJERSRISTE	20
GULV TILBEHØR	22
BEFÆSTELSE I GULV	24
STISYSTEMER	
PLANKER 35 & 40 MM	25
STOLPER 35/500 & 40/580	27
ACO FUNKI STOLPER 35/500	28
STOLPER 35/800 & QUICK-LOCK 35/820	29
STOLPER 35/800	30
STOLPER 40/800 & QUICK-LOCK 40/820	31
STOLPER 35/1000 & 40/1100	32
QUICK-LOCK 35/1100 & 40/1100	33
ÉN-HÅNDSLÅS 35/1100 1,5 & 2,0 MM	34
AUTO-LOCK 40 MM	35
MONTAGESÆT TIL SANDWICH PANEL	37
GELÆNDERBESLAG	38
STALDDØRE	39
STALDVINDUER	40
MILJØ- OG AFVANDINGSTEKNIK	41
INN-O-LED PLUG AND PLAY	43
MASTER LAMP	46
FUNKI LAMP	46
INTELLI HEAT	47
MASTER HEATER	47
KADAVERVOGN	48
VASKEROBOT	49
SALGS- OG LEVERINGSBETINGELSER	50

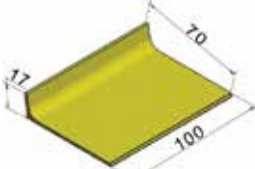
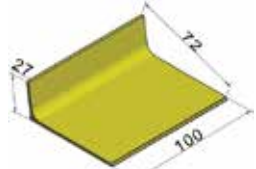
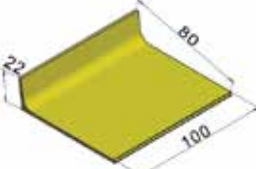
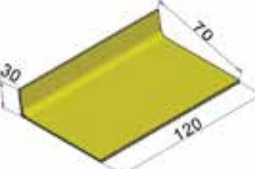
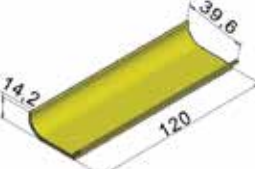
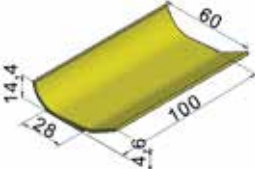







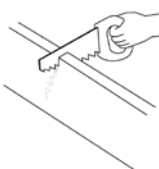



<p>Polymer krybber til grise</p>	 <p>17025 TSR100 RUNDTRUG F/ AUTOMAT</p>	 <p>02564 TS 25, 100 CM LANG</p>	 <p>02566 ENDEGAVL TIL TS 25</p>	 <p>02850 SKILLEVÆG TIL TS 25</p>
 <p>18444 TS 28 V, 100 CM LANG TIL LIM</p>	 <p>18445 SKILLEVÆG TIL TS 28 V</p>	 <p>01605 TS 30, 100 CM LANG</p>	 <p>17096 ENDE KRYBBE TS 30 100 CM LANG</p>	 <p>17097 ENDE KRYBBE TS 30 65 CM LANG</p>
 <p>01664 SKILLEVÆG TIL TS 30</p>	 <p>01667 TS 35, 100 CM LANG</p>	 <p>17081 ENDE KRYBBE TS 35H 50 CM LANG</p>	 <p>17080 ENDE KRYBBE TS 35V 50 CM LANG</p>	 <p>01670 SKILLEVÆG TIL TS 35</p>













 <p>02571 TS 36, 100 CM LANG</p>	 <p>17098 ENDE KRYBBE TS 36H 50 CM LANG</p>	 <p>17099 ENDE KRYBBE TS 36V 50 CM LANG</p>	 <p>02605 SKILLEVÆG TIL TS 36</p>	 <p>554157 KRYBBE 110 120 CM LANG</p>
 <p>554152 ENDE KRYBBE 110-SV 120 CM LANG</p>	 <p>554151 ENDE KRYBBE 110-SH 120 CM LANG</p>	 <p>554170 SKILLEVÆG TIL 110</p>	 <p>03191 TS 41, 100 CM LANG</p>	 <p>01595 ENDE KRYBBE TS 41, 100 CM LANG</p>
 <p>01596 ENDE KRYBBE TS 41, 65 CM LANG</p>	 <p>03204 SKILLEVÆG TIL TS 41</p>	 <p>01585 TS 47, 100 CM LANG</p>	 <p>01586 ENDE KRYBBE TS 47, 100 CM LANG</p>	 <p>01587 ENDE KRYBBE TS 47, 65 CM LANG</p>
 <p>03260 RF PROP TIL SVINEKRYBBE RENSEÅBNING</p>	 <p>02101 TS 50, 100 CM LANG</p>	 <p>01600 ENDE KRYBBE TS 50, 100 CM LANG</p>	 <p>01601 ENDE KRYBBE TS 50, 65 CM LANG</p>	 <p>09518 REPOS TS 100, 100 CM LANG</p>
 <p>09519 REPOS TS 65, 65 CM LANG</p>	 <p>554201 KRYBBE 105-R 120 CM LANG</p>	 <p>554203 ENDE KRYBBE 105-R 120 CM LANG</p>	 <p>554128 KRYBBE 116 120 CM LANG</p>	 <p>554162 SKILLERUM 116</p>

 <p>09550 ENKELTTRUG T35-50, TIL NEDSTØBNING</p>	 <p>09552 ENKELTTRUG T35-60, TIL NEDSTØBNING</p>	 <p>18333 ENKELKRYBBE T39-49,5 MED PROP</p>	 <p>17298 ENKELTTRUG DT 14 L MED PROP</p>	 <p>17297 ENKELTTRUG DT 14 R MED PROP</p>
 <p>17300 ENKELTTRUG DT 20 L MED PROP</p>	 <p>17299 ENKELTTRUG DT 20 R MED PROP</p>	 <p>18068 M25X1,5 POLYAMID-66 LÅS FOR POLYTRUG</p>		









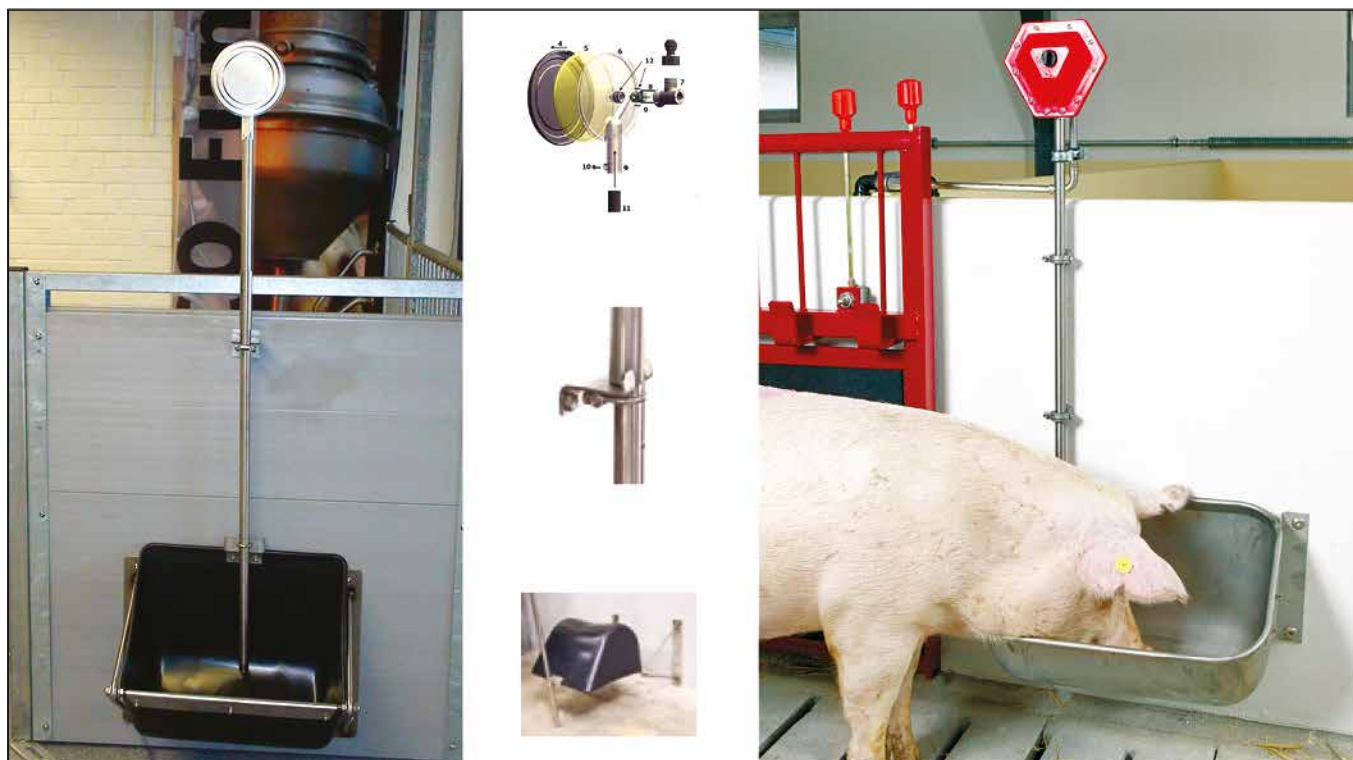





Polymer krybber til kvæg	 <p>09655 FODERBORD KL 60 100 CM LANG</p>	 <p>17385 FODERBORD KL 70 S 100 CM LANG</p>	 <p>02326 FODERBORD KL 70 100 CM LANG</p>	 <p>09693 FODERBORD KL 72 100 CM LANG</p>
	 <p>09657 FODERBORD KL 80 100 CM LANG</p>	 <p>18268 FODERBORD KL 100 70 CM LANG</p>	 <p>554135 FODERBORD 202 120 CM LANG</p>	 <p>02080 FODERBORD KM 60 100 CM LANG</p>
Rustfri krybber	 <p>18011 TRUG DT 20 VENSTRE RUSTFRI</p>	 <p>18012 TRUG DT 20 HØJRE RUSTFRI</p>		
	Tilbehør til krybber	 <p>74520 FLEXIBEL FUGEMASSE 300ML</p>	 <p>18990 FUGEMØRTEL FOR FODERBORD</p>	 <p>18435 POLYESTER KLÆBMASSE 4 KG 150g PR. FUGE, 250g PR. SKILLERUM</p>
 <p>523003 BLANDESPIDS</p>		 <p>560308 ACO FUNKI COMPONENT FIX</p>	 <p>18422 SKÆRETILLÆG OP TIL 40KG/27CM</p>	







<p>Skåle og drikke-kopper</p>	 <p>560395 FODERSKÅL Ø24 RF MED KROG 2,5LITER</p>	 <p>03186 FT 19 FODERSKÅL 19 X 8 CM</p>	 <p>06906 RUNDKRYBBE FTK 27 MED KEGLE OGINDER KANT 27 X 8 CM</p>	 <p>554154 FODERSKÅL 326-T 26 X 6 CM</p>
 <p>96061 FODERSKÅL SMÅGRISE DIA-METER 26CM</p>	 <p>96063 FODERSKÅL SMÅGRISE DIA-METER 39 CM</p>	 <p>90012 FODERSKÅL MINI PATTEGRISE INKL. BESLAG</p>	 <p>90013 FODERSKÅL MINI PATTEGRISE INKL. BOLT/MØTRIK</p>	 <p>90144 OPHÆNGSBESLAG TIL MINI FODERSKÅL</p>
 <p>93570 DRIK-O-MAT® MINI</p>	 <p>93575 DRIK-O-MAT® STANDARD</p>	 <p>93600 DRIK-O-MAT® MULTI</p>	 <p>93500 DRIK-O-MAT MAXI</p>	 <p>93250 VIPPEVENTIL DRIK-O-MAT® 1/2" UDVENDIGT GEVIND</p>

 <p>560120 MINI DRIKKEKOP KOMPLET</p>	 <p>560130 STANDARD DRIKKEKOP KOMPLET</p>	 <p>560140 MULTI DRIKKEKOP KOMPLET</p>	 <p>560160 MAXI DRIKKEKOP KOMPLET</p>	 <p>560153 304SS VENTIL 1/2" UDVENDIGT GEVIND TIL DRIKKEKOP</p>
 <p>93520 VIP-O-MAT INKL. SLANGEBE-SKYTTELSE</p>	 <p>43730 SMÅGRISEVANDER ENKELT I PLAST</p>	 <p>93345 SUTTEVENTIL 3/8" RF UDVENDIGT GEVIND TIL SMÅGRISE</p>	 <p>2100625 DRIKKEKOP TIL SMÅGRISE MED LANGT RØR</p>	 <p>2100622 RUSTFRI SMÅGRISE DRIKKEKOP</p>
 <p>12100108 DRIKKE VENTIL FOR SMÅGRISE DRIKKEKOP RUSTFRIT</p>	 <p>550489 DRIKKEKOP TIL SO/SMÅGRISE TYPE 20</p>	 <p>18960 MONTAGE SÆT TIL SO/SMÅGRISE DRIKKEKOP TYPE20</p>		





<p>Master Flow og Aqua Drop II</p>	 <p>93469 MASTER FLOW INKL. 1/2" PROP</p>	 <p>06902114 NIPPELRØR 1/2" RUSTFRI 1195 MM M/GEVIND</p>	 <p>06902115 NIPPELRØR 1/2" RUSTFRI 1495 MM M/GEVIND</p>	 <p>2950666 SO TRUG DYBTRUKKET RUSTFRI V2</p>
 <p>96054 BESLAGSÆT TIL SOTRUG INKL. BOLTE TIL MUR</p>	 <p>96056 BESLAGSÆT TIL SOTRUG INKL. BOLTE TIL PLANKE</p>	 <p>96058 BESLAGSÆT SOTRUG ENKELT MONTAGE PÅ TREMMER</p>	 <p>550490 AQUADROP II 1/2" MED AFSPÆRRINGSVENTIL</p>	 <p>550491 1/2" X 120 CM RØR TIL AQUADROP II</p>
 <p>550492 MEMBRAM TIL AQUADROP II</p>	 <p>1205902 VIPPETRUG TIL SØER MED OPHÆNG</p>	 <p>1205901 VIPPETRUG TIL SMÅGRISE PVC MED OPHÆNG</p>	 <p>1205903 VIPPETRUG TIL SMÅGRISE RUSTFRI MED OPHÆNG</p>	 <p>4900485 MONTAGESÆT FORVÆRK AQUA DROP</p>

 <p>4900486 MONTAGESÆT TREMMER AQUA DROP</p>	 <p>4900487 MONTAGESÆT PLANKER AQUA DROP</p>	 <p>4900488 MONTAGESÆT PANEL AQUA DROP</p>	 <p>4900489 MONTAGESÆT MUR AQUA DROP</p>
--	--	--	---

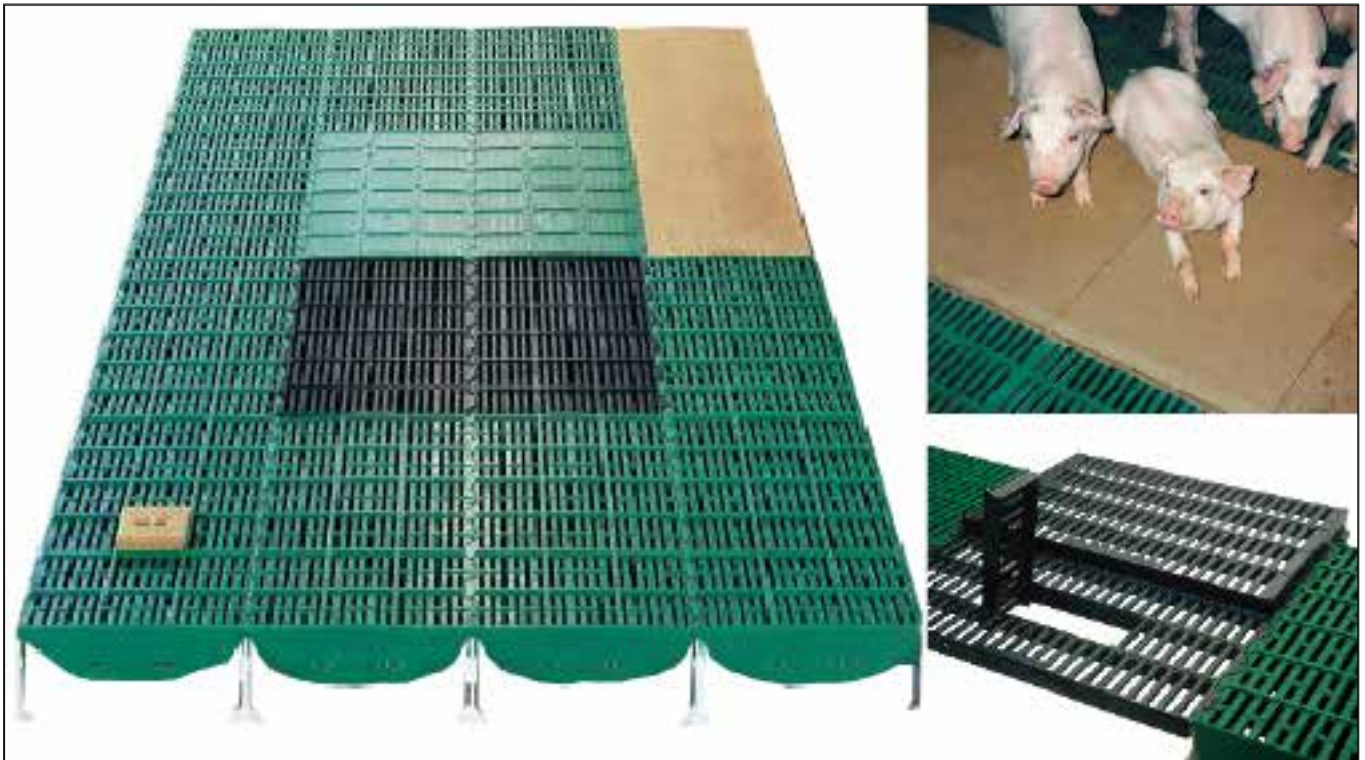

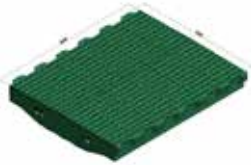
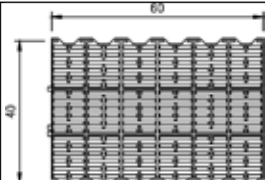
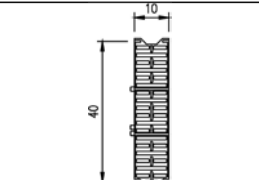
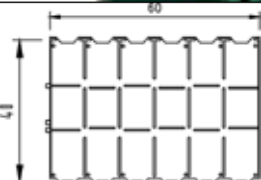
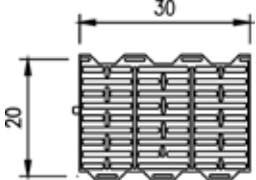
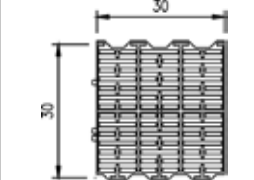
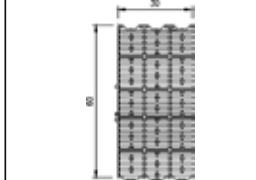

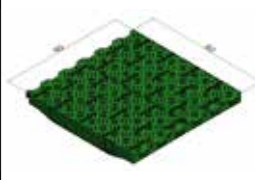
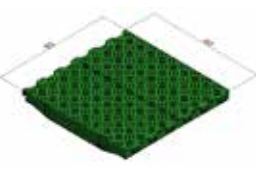
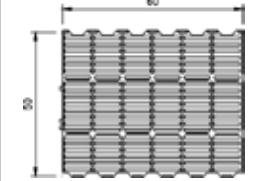
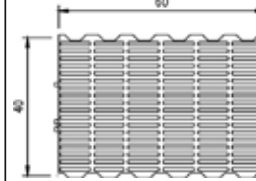
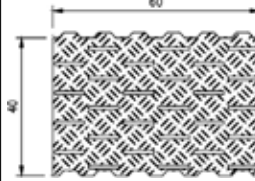
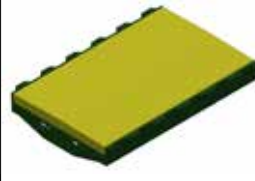
Kombiriste - Plastriste	 <p>565060 PLASTRIST 60X50 CM TIL SØER, 50% ÅBNING</p>	 <p>09102 PLASTRIST 60X40 CM FOR SØER, 50% ÅBNING</p>	 <p>18054 PLASTRIST 10X40 CM TIL SØER, 50% ÅBNING</p>	 <p>17383 PLASTRIST 60X40 CM TIL SØER, LUKKET</p>	
	 <p>18094 PLASTRIST 30X20 CM TIL SØER, 50% ÅBNING</p>	 <p>17328 PLASTRIST 30X30 CM TIL SØER, 50% ÅBNING</p>	 <p>18721 PLASTRIST 30X60 CM TIL SØER, 50% ÅBNING</p>	 <p>566360 PLASTRIST 60X60 CM TIL SMÅGRISE, 50% ÅBNING</p>	 <p>566260 PLASTRIST 60X60 CM TIL SMÅGRISE, 10% ÅBNING</p>
	 <p>566160 PLASTRIST 60X60 CM TIL SMÅGRISE, LUKKET</p>	 <p>17384 PLASTRIST 60X50CM TIL SMÅGRISE, 50% ÅBNING</p>	 <p>09100 PLASTRIST 60X40 CM FOR SMÅGRISE, 50% ÅBNING</p>	 <p>18604 PLASTRIST 60X40 CM TIL SMÅGRISE, 10% ÅBNING</p>	 <p>560310 FLISE KOMPLET 60X40</p>

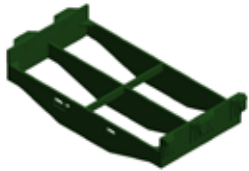









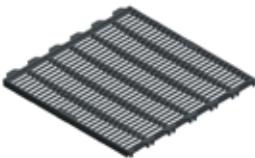

560300
PLASTRIST RAMME 200X400
MM, GRØN

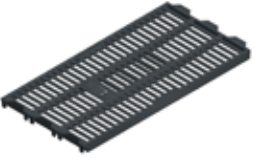

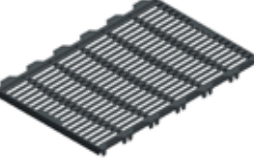
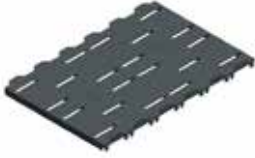
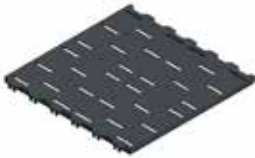











560305
FLISE TIL UNDER SOEN



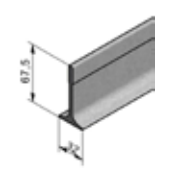
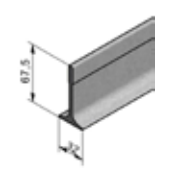

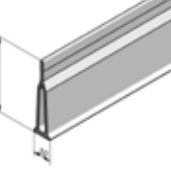
<p>Kombiriste - Støbejernriste</p>	 <p>566060 STØBEJERNSRIST 60X60 CM TIL SØER</p>	 <p>566063 STØBEJERNSRIST 60X60 CM TIL SØER, MED PROP</p>	 <p>566064 PROP TIL 566063 STØBE- JERNSRIST</p>	 <p>564060 STØBEJERNSRIST 40X60 CM TIL SØER</p>
 <p>563060 STØBEJERNSRIST 30X60 CM TIL SØER, MED PROP</p>	 <p>563061 PROP TIL 563060 STØBE- JERNSRIST</p>	 <p>561060 STØBEJERNSRIST 10X60 CM TIL SØER</p>	 <p>566040 STØBEJERNSRIST 60X40 CM TIL SØER</p>	 <p>566041 STØBEJERNSRIST 60X40 CM TIL SØER, 5% ÅBNING</p>
 <p>566042 STØBEJERNSRIST 60X60 CM TIL SØER, 5% ÅBNING</p>	 <p>564063 STØBEJERNSRIST 40X60 CM TIL SØER, LUKKET</p>	 <p>564061 STEP - STØBEJERNSRIST 40X60 CMTIL SØER</p>	 <p>564062 STEP - STØBEJERNSRIST 40X60 CM TIL SØER, LUKKET</p>	

<p>Kombiriste - Tilbehør</p>	 <p>554164 RENSEPROP, POLY, F/PLASTRIST L21 X B13 X H7 CM</p>	 <p>01777 RENSEPROP L13 X B10 X H15 CM</p>	 <p>18169 RENSELEM RF, FARESTI 38,5 X 18,5 CM</p>	 <p>18083 SIDELISTE TIL PLASTRIST, 20 CM</p>
 <p>17666 ENDELISTE 40 X 4 CM TIL RISTE40 CM</p>	 <p>17667 ENDELISTE 40 X 6 CM TIL SORIST 40 CM</p>	 <p>8500301 AFSTANDSTYKKE TIL PVC GULV 30X40X58,3 MM</p>	 <p>09105 ENDESTYKKE TIL PLASTRIST GRØN</p>	 <p>34900012 PLADESKRUE 4,2X25 PH X- KÆRV A2 DIN 7981 C</p>



<p>Bæring</p>	 <p>17193 BÆRING 120X32 MM GLASFIBER 6 METER</p>	 <p>17194 BÆRING 120 X 32 MM, SPECIAL LÆNGDE</p>	 <p>560189 FIBER BÆRING 70 X 32 MM 5,9 METER</p>	 <p>560193 FIBER BÆRING 120 X 32 MM 5,9 METER</p>
 <p>7910193 FIBER BÆRING 120 X 32 MM SPECIAL LÆNGDE</p>	 <p>5632193 FIBER BÆRING 120 X 32 MM SPECIAL LÆNGDE 6+</p>	 <p>560285 BÆRING 120 X 30 MM, 2,85 METER (DELTA)</p>	 <p>7910189 FIBER BÆRING 70 X 32 MM SPECIAL LÆNGDE</p>	 <p>5632189 FIBER BÆRING 70 X 32 MM SPECIAL LÆNGDE 6+</p>
 <p>560290 BÆRING 120 X 30 MM, GLASFIBER 9 METER (DELTA)</p>	 <p>7910290 FIBER BÆRING 120 X 30 MM (DELTA) SPECIAL LÆNGDE</p>	 <p>2900630 MONTAGESÆT VÆGHOLDER TIL GULV 1150 MM</p>	 <p>2100619 Z SUPPORT 135 MM TIL 120 MM BÆRING, KOMPLET</p>	 <p>96980 FOD TIL STØTTEBEN GLASFIBERBÆRINGER</p>

 <p>96981 RØR STØTTEBEN GLASFIBER- RUNDERSTØTNING, LÆNGDE 5 METER</p>	 <p>96982 FOD FOR GLASFIBER BÆRING</p>	 <p>560192 FOD FOR GLASFIBER BÆRING, 560193 OG 560194</p>	
---	--	---	--









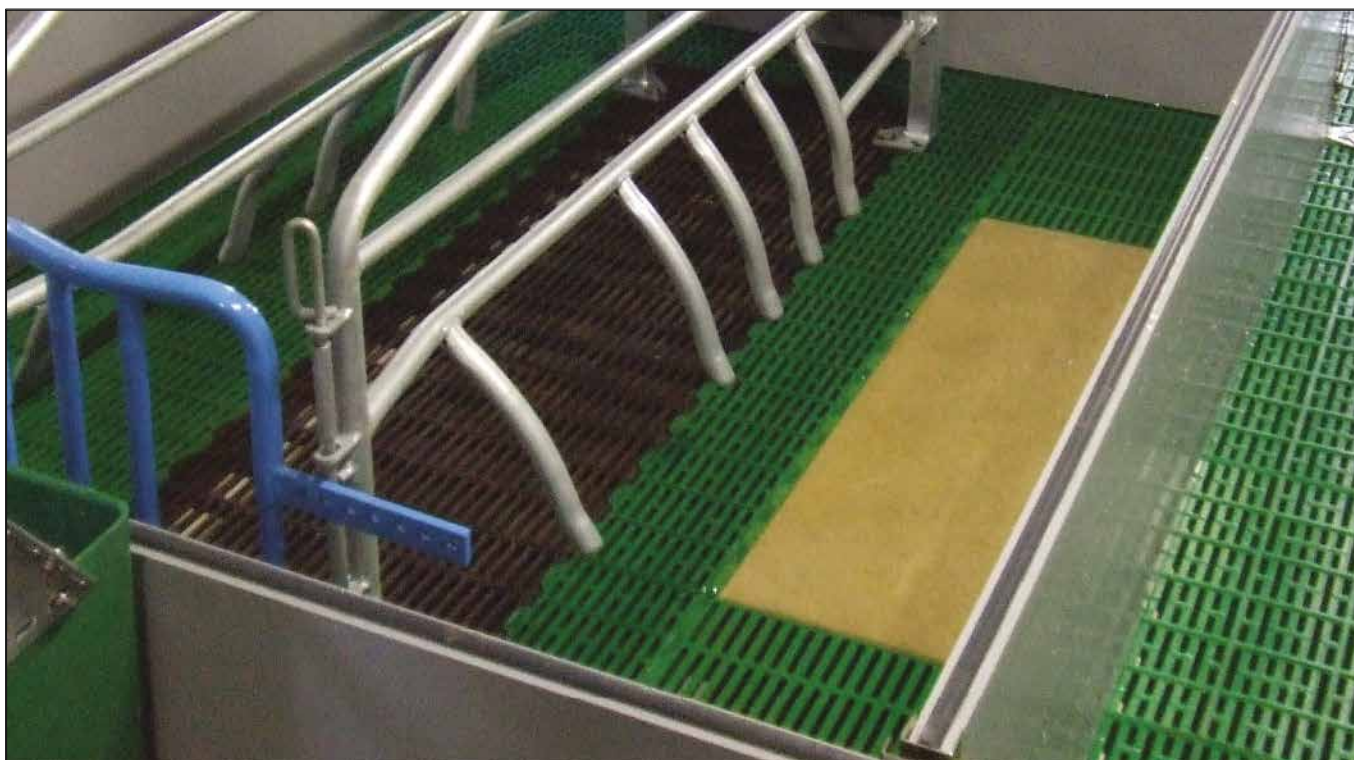



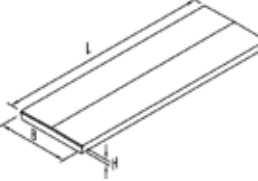
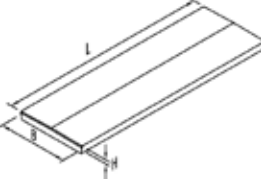
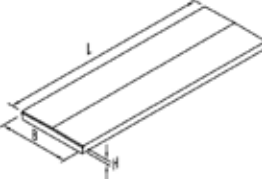







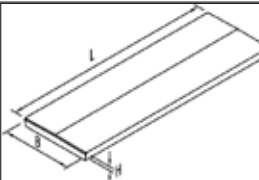
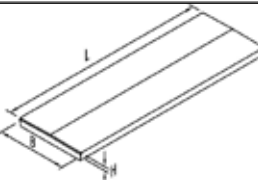
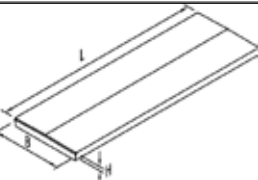

MAX. SPÆNDVIDDE, FIBERBÆRINGER

Bæring	SMÅRISE		FARESTIER
	60x60 cm	60x40 & 60x50 cm	60x40 & 60x50 cm
70 x 32 mm	1500 mm	1600 mm	-
120 x 32 mm	2600 mm	2800 mm	2500 mm*
120 x 30 mm (Delta)	2800 mm	3000 mm	2800 mm*



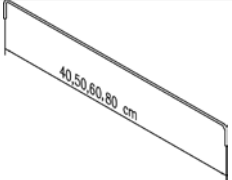

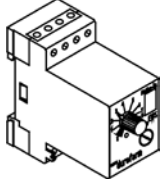







* Ved almindelig faresti: 3 stk. supports under soen
 * Ved Welsafe faresti: Supports under alle bæring

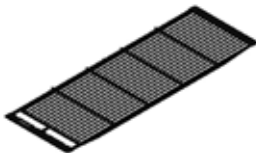

<p>Varmeplade systemer</p>	 <p>18948 PLAST VARMEPLADE TIL 120X40 E 80W, HØJRE</p>	 <p>18961 PLAST VARMEPLADE TIL 120X40 E 80W, VENSTRE</p>	 <p>18962 STYRING TIL VARMEPLADE 2200W</p>	 <p>12630 VARMEVANDSPLADE 140X50 CM, 240W M/ 1/2' RØR INV. GEVIND PVC</p>
 <p>17582 ELEKTRISK VARMEPLADE 120X40 CM - 230V, 130W POLYMER</p>	 <p>12631 VARMEVANDSPLADE 120X40 CM, 240W M/ 1/2' RØR INV. GEVIND PVC</p>	 <p>560312 VARME UNIT 2 KREDSE</p>	 <p>560313 VARME UNIT 3 KREDSE</p>	 <p>560314 VARME UNIT 4 KREDSE</p>
 <p>560311 REGULATOR SÆT</p>	 <p>17317 VARMESLANGE 17X2 MM</p>	 <p>17169 TILSLUTNINGSVINKEL, 2 STK. PR. SÆT, SELVTÆTNENDE, 1/2", 17 X 2MM</p>	 <p>17182 TILSLUTNINGSSTUDS, 2 STK. PR. SÆT</p>	 <p>18914 BESKYTTELSESPLADE 1200 MM X 150 MM, RUSTFRIT</p>

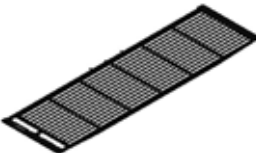
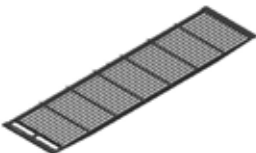





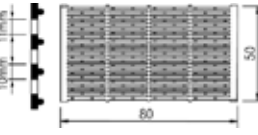
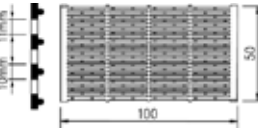
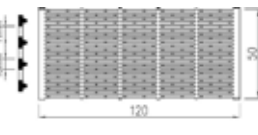
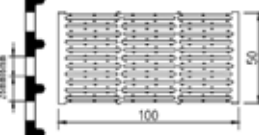
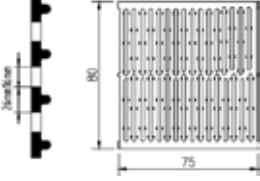





 <p>18409 ELEKTRISK VARMEPLADE 120X50 CM - 230V, 180W</p>	 <p>17792 ELEKTRISK VARMEPLADE 120X80 CM - 230V, 270W</p>	 <p>18855 ELEKTRISK VARMEPLADE 140X50 CM - 230V, 180W</p>	 <p>560503 FØLER TIL ELEKTRISK VARME- PLADE POLYMER</p>	 <p>560515 STYRING TIL ELEKTRISK VARMEPLADE POLYMER 2200 W INKL. FØLER</p>	
 <p>4960560 OPHÆNGSSÆT TIL VARME- PLADER</p>	 <p>4960614 OPHÆNGSSÆT TIL VARME- PLADE PÅ DELTA BÆRING</p>	 <p>17274 STÅLBØJLE TIL AKSIALE DIMENSION 40 CM VARME- PLADE</p>	 <p>17367 STÅLBØJLE TIL AKSIALE DIMENSION 50 CM VARME- PLADE</p>	 <p>17363 STÅLBØJLE TIL AKSIALE DIMENSION 80 CM VARME- PLADE</p>	
 <p>09593 FØLERKABEL 3,40 M</p>	 <p>09506 KONTAKT TIL MANUELT JUSTE- RINGEWS 1 450W TIL 230V POLYMERVARMEPLADE</p>				
<p>Gummimåtte</p>		 <p>27000024 GUMMIMÅTTE EN RULLE BREDE 1,2METER, LÆNGDE 30 METER</p>	 <p>7910116 GUMMIMÅTTE EN RULLE BREDE 1,2 METER, SPECIAL LÆNGDE</p>		







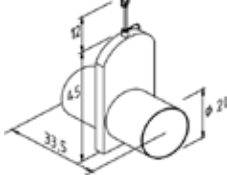
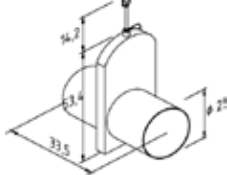















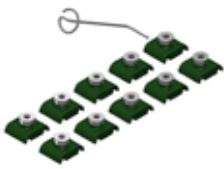









Selv bærende Støbejernsriste	 <p>560800 STØBERIST 80X40X3 CM M/ RENSÅBNING, 10/11 MM SPALTEÅBNING</p>	 <p>560900 STØBERIST 90X40X3 CM M/ RENSÅBNING, 10/11 MM SPALTEÅBNING</p>	 <p>561000 STØBERIST 100X40X3 CM M/RENSÅBNING, 10/11 MM SPALTEÅBNING</p>	 <p>561100 STØBERIST 110X40X3 CM M/RENSÅBNING, 10/11 MM SPALTEÅBNING</p>	
	 <p>549655 STØBERIST 120 X 40 CM M/ RENSÅBNING, 10/11 SPALTE- ÅBNING</p>	 <p>561400 STØBERIST 140X40X3 CM M/RENSÅBNING, 10/11 MM SPALTEÅBNING</p>	 <p>561600 STØBERIST 160X40X3 CM M/RENSÅBNING, 10/11 MM SPALTEÅBNING</p>	 <p>561203 STØBERIST 120X40X3 CM M/RENSÅBNING, 12/13 MM SPALTEÅBNING</p>	 <p>549800 STØBERIST 140 X 40 CM M/ RENSÅBNING, 12/13 MM SPALTEÅBNING</p>
	 <p>549656 STØBERIST 160 X 40 CM M/ RENSÅBNING, 12/13 MM SPALTEÅBNING</p>	 <p>561803 STØBERIST 180X40X3 CM M/RENSÅBNING, 12/13 MM SPALTEÅBNING</p>	 <p>549849 STØBERIST 200 X 40 CM M/ RENSÅBNING, 12/13 MM SPALTEÅBNING</p>	 <p>560111 AFDÆKNINGSRIBBE TIL ÉN STØBEJERNSRIST TIL 56xxx</p>	 <p>92630 AFDÆKNINGSRIBBE STØBE- JERNSRIST 92xxx og 54xxx</p>

 <p>18878 AFDÆKNINGSRIBBE TIL REN- SEÅBNING TIL EB RISTE 95xxx</p>	 <p>17339 STØBERIST 80 X 50 CM, 10/11 MM SPALTEÅBNING</p>	 <p>17341 STØBERIST 100 X 50 CM, 10/11 MM SPALTEÅBNING M/ SKRIDSIKRING</p>	 <p>17342 STØBERIST 120 X 50 CM, 10/11 MM SPALTEÅBNING M/ SKRIDSIKRING</p>	 <p>17253 STØBERIST 100 X 50 CM, 26/16 MM SPALTEÅBNING M/ SKRIDSIKRING</p>
 <p>17197 STØBERIST 80 X 75 CM 26/16 MMSPALTEÅBNING MED SKRIDSIKRING</p>				











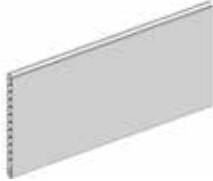
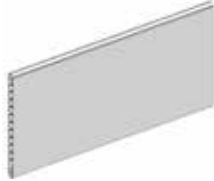

<p>Gulv tilbehør</p>	 <p>550697 ACO FUNKI PROTECT BASIS 1KG</p>	 <p>550698 ACO FUNKI PROTECT BASIS 5KG</p>	 <p>550699 ACO FUNKI PROTECT BASIS 30KG</p>	 <p>550700 ACO FUNKI PROTECT BASIS 1000KG</p>
 <p>550701 ACO FUNKI PROTECT TOP COLOR 1KG</p>	 <p>550702 ACO FUNKI PROTECT TOP COLOR 5KG</p>	 <p>550703 ACO FUNKI PROTECT TOP COLOR 30 KG</p>	 <p>550704 ACO FUNKI PROTECT TOP COLOR 1000KG</p>	 <p>550705 RENGØRINGSMIDDEL OG KALKFJERNER 5 LITER, ANVENDES FØR BRUG AF PROTECT 50-100 M2</p>
 <p>562500 LUK SPALTEN QUICK MODEL HELE LÆNGDE A 250 CM</p>	 <p>18077 SKYDESPJÆLD DN 200</p>	 <p>18574 GYLLESKYDESPJÆLD DN 250 RF</p>	 <p>17334 GYLLEPROP DN 150, A:205 X B:150 MM</p>	 <p>17016 GYLLEPROP DN 200, A:232 X B:181 MM</p>

 <p>17161 GYLLEPROP DN 250, A:284 X B:233 MM</p>	 <p>17162 GYLLEPROP DN 300, A:339 X B:284 MM</p>	 <p>18404 GYLLEPROP DN150 MED FLAD BØJLE 155X30 MM, A:205 X B:150 MM</p>	 <p>18918 GYLLEPROP DN150 MED FLAD BØJLE 50X30 MM, A:205 X B:150 MM</p>	 <p>18496 GYLLEPROP DN150 MED FLAD BØJLE100X25 MM, A:205 X B:150 MM</p>
 <p>18597 LÅSE PROP DN100 MED FLAD BØJLE100X31,5 MM, A:130 X B:95 MM</p>				

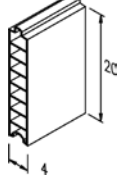
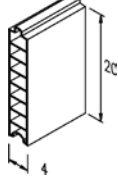
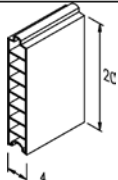
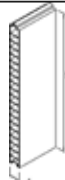
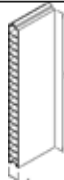

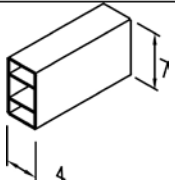

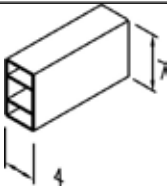

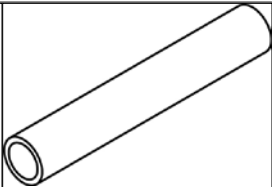

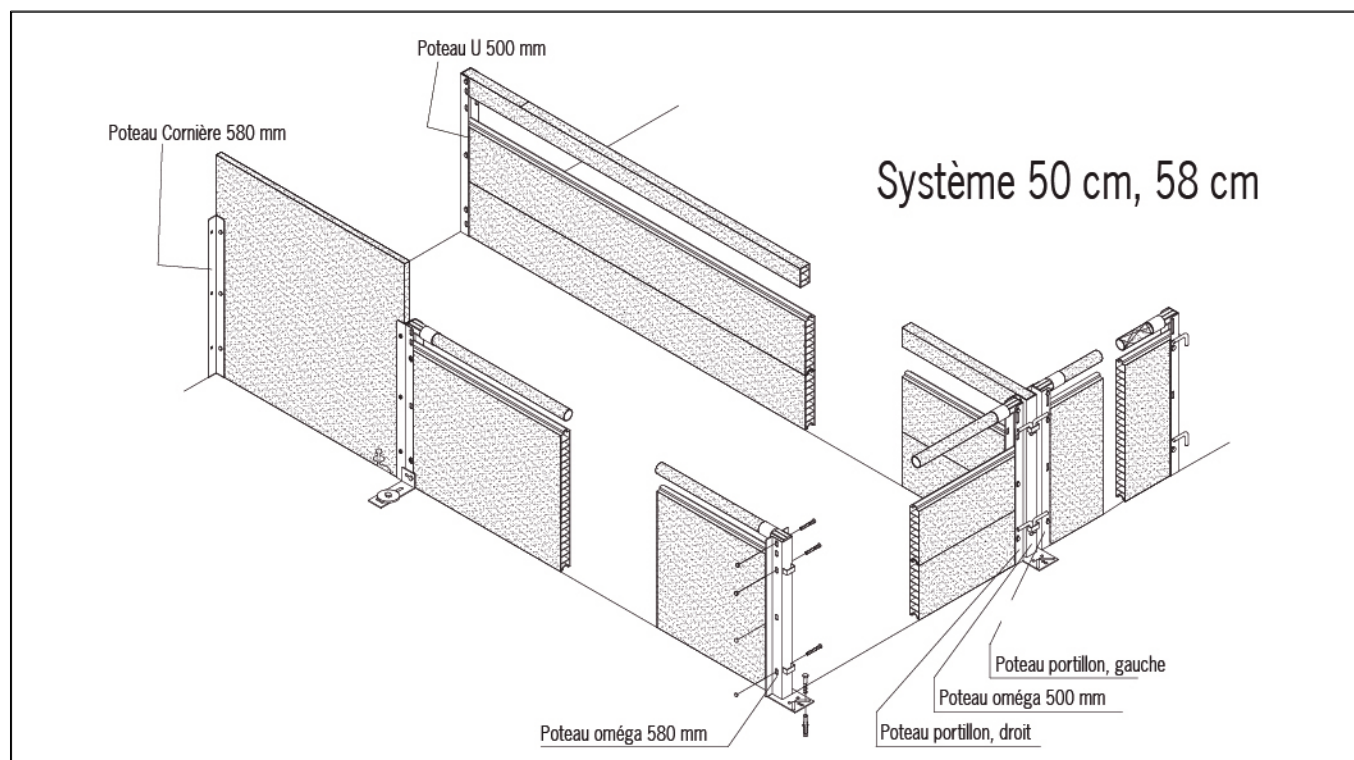

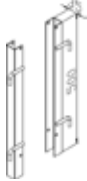
<p>Befæstelse i Gulv</p>	 <p>4800010 10 STK RF FRANSK 10x70 + DYBEL</p>	 <p>4800008 10 STK PÅBOLTINGSBESLAG MED 2GEVIND TIL STØBEJERNRISTE</p>	 <p>96967 10 STK PÅBOLTINGSBESLAG LILLE TIL STØBEJERNRISTE</p>	 <p>1900241 10 STK PÅBOLTINGSBESLAG STORTIL STØBEJERNRISTE</p>
 <p>1900515 SPALTEANKER 8 MM GRØN, 10 STYK 30X35X9 MM EKSKL. SKRUER</p>	 <p>4800025 10 STK ANKER SÆT M8 80-115 MM</p>	 <p>4800030 10 STK ANKER SÆT M8 100-130 MM</p>	 <p>4800035 10 STK ANKER SÆT M8 130-160 MM</p>	 <p>4800040 10 STK ANKER SÆT M8 100-130 MM</p>
 <p>4800045 10 STK ANKER SÆT M8 120-150 MM</p>	 <p>4800050 10 STK ANKER SÆT M8 150-180 MM</p>	 <p>29100066 GEVINDSIKRING STÆRK, ACO FUNKI 250 ML TIL 150 SKRUER</p>	 <p>29100067 GEVINDSIKRING STÆRK, ACO FUNKI</p>	 <p>17095 SPALTEANKER 8 MM, GRØN (10STK) 40 X 30 X 15 MM</p>
 <p>17129 SPALTEANKER 10 MM GRØN (10STK) 40 X 30 X 15 MM</p>	 <p>18958 SKRUEANKER ROMBE SMÅGR. RIST(POSE MED 10 STK.)</p>	 <p>4800871 10 STK. T-BOLT TIL 80-100 MM BETON SPALTER RUSTFRI</p>	 <p>4800875 10 STK. T-BOLT TIL 90-120 MM BETON SPALTER RUSTFRI</p>	 <p>4800876 10 STK. T-BOLT TIL 120-150 MM BETON SPALTER RUSTFRI</p>
 <p>4800020 10 STK. T-BOLT TIL 80-130 MM BETON SPALTER RUSTFRI</p>	 <p>90100079 50 MM FORSKUDT T-BOLT</p>	 <p>30310120 RUNDHOVEDE TORX 50 M10X120 RF</p>	 <p>30872 RUNDHOVEDE TORX 50 M10X90 RF</p>	 <p>30310080 RUNDHOVEDE TORX 50 M10X80 RF</p>











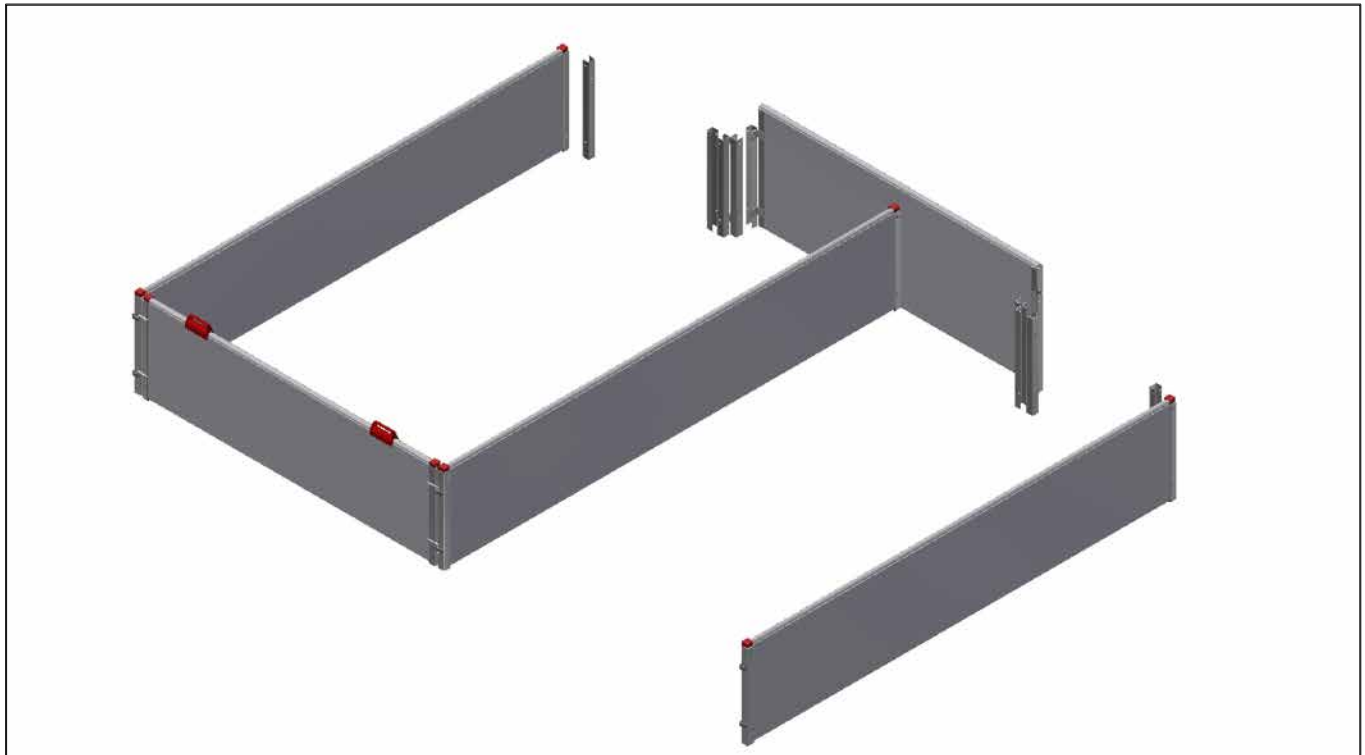



Planker 35 og 40 mm	 <p>7910099 PLANKE 35X250 MM SPEC. LÆNGDE</p>	 <p>30100 PLANKE 35X250 MM LÆNGDE 6 METER</p>	 <p>7910102 PLANKE 35X500 MM SPEC. LÆNGDE</p>	 <p>30103 PLANKE 35X500 MM LÆNGDE 6 METER</p>	
	 <p>7910105 PLANKE 35X750 MM SPEC. LÆNGDE</p>	 <p>30106 PLASTPLANKE 35X750 MM LÆNGDE 6 METER</p>	 <p>2900358 U-PROFIL PLAST 6 METER</p>	 <p>8640206 PLANKE 40X200 FEDER/NOT 6 METER</p>	 <p>8640207 PLANKE 40X200 FEDER/NOT SPEC. LÆNGDE 6+</p>
	 <p>7910461 PLANKE 40X200 FEDER/NOT SPEC. LÆNGDE</p>	 <p>8640506 PLANKE 40X500 FEDER/NOT 6 METER</p>	 <p>8640507 PLANKE 40X500 FEDER/NOT SPEC. LÆNGDE 6+</p>	 <p>7910471 PLANKE 40X500 FEDER/NOT SPEC. LÆNGDE</p>	 <p>18276 FIRKANTPROFIL 70X40, 6,0 METER</p>

 <p>7910004 PLANKE 70X40 SPECIAL LÆNGDE</p>	 <p>17005 ENDEKAPPE TIL 70X40 PROFIL</p>	 <p>1900240 1" RØR GALVANISERET 6 METER M/SAMLEMUFFE, PRIS PR. STK. LÆNGDE 6 METER</p>	









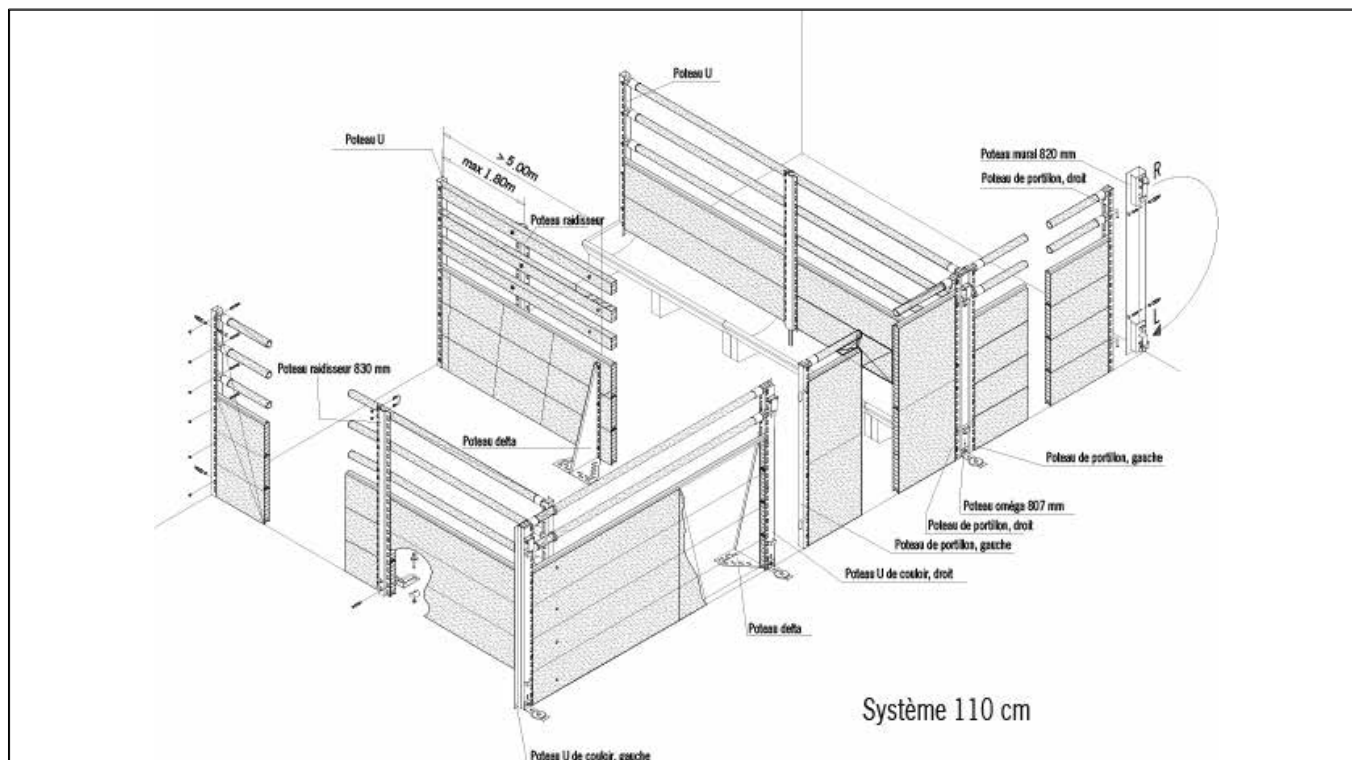





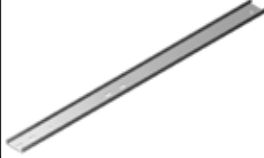

35/500 og 40/580	 <p>550278 U-STOLPE, 35/500 MM</p>	 <p>550279 U-DØRSTOLPE, PAR 35/500 MM V09</p>	 <p>550282 GANGSTOLPE, MIDT 35/500 MM V09</p>	 <p>550283 GANGSTOLPE, VÆG 35/500 MM V09</p>	
	 <p>17759 U-STOLPE 40/580</p>	 <p>17766 U-DØRSTOLPE, RF PAR (H+V) 58CM</p>	 <p>17760 U-GANGSSTOLPE MIDT 40/580</p>	 <p>17763 U-GANGSTOLPE 40/580</p>	 <p>17776 VINKEL STOLPE 40/580</p>
	 <p>17762 U-GANGSTOLPE VENSTRE 40/580</p>	 <p>17761 U-GANGSTOLPE HØJRE 40/580</p>			





















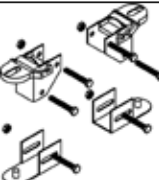











ACO FUNKI 35/500	 8450603 UPROFIL TIL VÆG H75 FARESTI ES	 8450596 UPROFIL FARESTI MED HUL ES 500	 8450634 UPROFIL FARESTI ES 600	 8450595 UPROFIL FARESTI ES 500	
	 2150011 VENSTRE STOLPE TIL LÅGE	 2150012 HØJRE STOLPE TIL LÅGE	 2150010 STOLPE H500 FARESTI ES	 2150013 VENSTRE STOLPE H50 FARESTI ES	 2150014 HØJRE STOLPE H50 FARESTI ES
	 2150016 VÆG HÆNGER H50 SIDEVENDT FARESTI ES	 2150015 UPROFIL H50 SIDEVENDT FARESTIES			

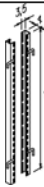







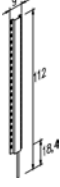

35/800 og Quick-Lock 35/820	 <p>550284 U-STOLPE 35/807 V09</p>	 <p>550285 U-DØRSTOLPE, PAR 35/807 V09</p>	 <p>550288 U-GANGSTOLPE, MIDT 35/807 V09</p>	 <p>550289 U-GANGSTOLPE, VÆG 35/807 V09</p>
	 <p>550290 U-GANGSTOLPE, V. 35/807 V09</p>	 <p>550291 U-GANGSTOLPE, H. 35/807 V09</p>	 <p>550292 Y-GANGSTOLPE 35/807 V09</p>	 <p>550293 STABILISATOR 35/807 V09</p>
 <p>554332 QUICK-LOCK LÅGE STOLPE FOR 35MM PLANKE H=820 MM</p>	 <p>554333 QUICK-LOCK U-GANG STOLPE FOR 35 MM PLANKE H=820 MM</p>			

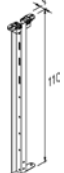

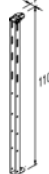
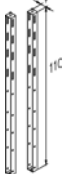
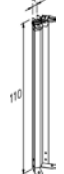





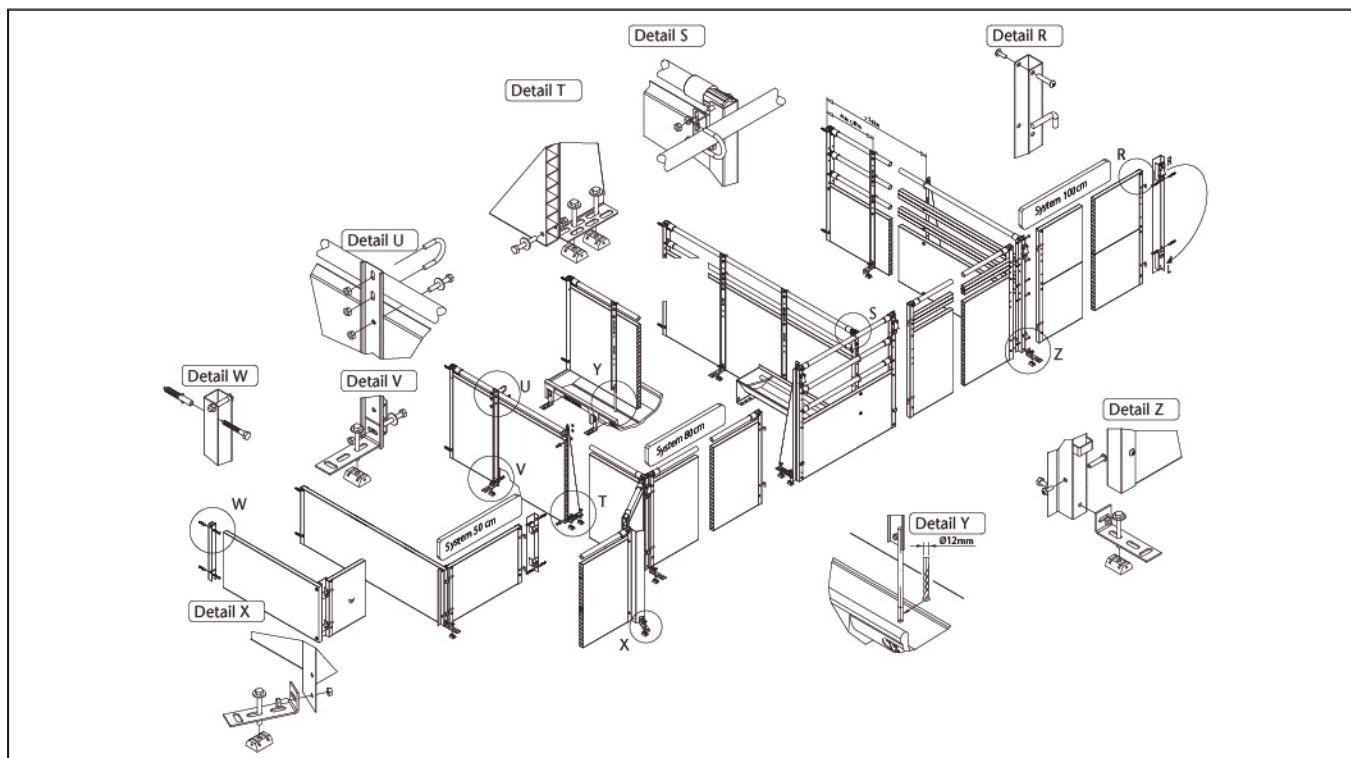





<p>Stolper 35/800</p>	 <p>8450812 UPROFIL H820 MM 35 MM</p>	 <p>568102 HØJRE STOLPE H820 MM TIL LÅGE</p>	 <p>568101 VENSTRE STOLPE H820 MM TIL LÅG</p>	 <p>568100 STOLPE H820 MM QUICK LOCK</p>
 <p>568104 HØJRE STOLPE H820 MM 35 MM</p>	 <p>568103 VENSTRE STOLPE H820 MM 35 MM</p>			

















40/800 og Quick-Lock 40/821	 <p>17750 U-STOLPE 40/820</p>	 <p>17758 U-DØRSTOLPE, RF PAR (H+V) 82CM</p>	 <p>17751 U-GANGSTOLPE MIDT 40/820</p>	 <p>17754 U-GANGSTOLPE 40/820</p>
	 <p>17753 U-GANGSTOLPE VENSTRE 40/820</p>	 <p>17752 U-GANGSTOLPE HØJRE 40/820</p>	 <p>17757 STABILISATOR 40/820 H=840 MM</p>	 <p>17555 DELTASTOLPE H=83 CM</p>
 <p>18353 QUICK-LOCK DØRSTOLPE-PAR 82CM</p>	 <p>18354 QUICK-LOCK Y-GANGSTOLPE, 82 CM</p>	 <p>18356 QUICK-LOCK FRONTPLADE SÆT</p>		



















35/1000 og 40/1100	 <p>550295 U-STOLPE 35/1007 V09</p>	 <p>550296 U-DØRSTOLPE PAR 35/1007 V09</p>	 <p>550299 U-GANGSTOLPE MIDT 35/1007 V09</p>	 <p>550300 U-GANGSTOLPE VÆG 35/1007 V09</p>	
	 <p>550301 U-GANGSTOLPE V. 35/1007 V09</p>	 <p>550302 U-GANGSTOLPE H. 35/1007 V09</p>	 <p>550303 Y-GANGSTOLPE 35/1007 V09</p>	 <p>550304 STABILISATOR 35/1030 V09</p>	 <p>550305 DELTASTOLPE 35/1030 V09</p>
	 <p>550308 TRUG VÆG STABILISATOR STANDARD 35/1000</p>	 <p>17739 U-STOLPE, 112 CM HØJ</p>	 <p>17740 U-STOLPE, 94 CM HØJ</p>	 <p>17743 U-DØRSTOLPE, PAR</p>	 <p>17735 U-GANGSTOLPE, MIDT</p>
	 <p>17736 GANGSTOLPE, VÆG ANVENDES TIL HØJRE OG TIL VENSTRE</p>	 <p>17738 U-GANGSTOLPE, VENSTRE (TIL GANGVÆG)</p>	 <p>17737 U-GANGSTOLPE, HØJRE (TIL GANGVÆG)</p>	 <p>17853 Y-GANGSTOLPE</p>	 <p>17744 STABILISATOR, 112 CM HØJ</p>
	 <p>17556 DELTAPFOSTEN H=1120 MM</p>	 <p>17745 STABILISATOR MED DORN, 112 CM HØJ</p>			

<p>Quick-Lock 35/1100 og 40/1100</p>	 <p>554331 QUICK-LOCK GANG STOLPE FOR 35 MM PLANKE H=1100 MM</p>	 <p>554330 QUICK-LOCK LÅGE STOLPE FOR PLANKE 35 MM H=1100 MM</p>	 <p>18342 QUICK-LOCK GANGSTOLPE MIDT</p>	 <p>18946 QUICK-LOCK GANG STOLPE VÆG 1100 MM 3,0 MM</p>
 <p>18345 QUICK-LOCK GANGSTOLPE, ANVENDES TIL HØJRE OG TIL VENSTRE (TIL GANGVÆG)</p>	 <p>18355 QUICK-LOCK DØRSTOLPE, PAR</p>	 <p>18343 QUICK-LOCK Y-DØRSTOLPE</p>	 <p>18340 QUICK-LOCK POLYMERBETON FRONTPLADE 30X113 CM</p>	 <p>18339 QUICK-LOCK POLYMERBETON FRONTPLADE 60X113 CM</p>
 <p>18356 QUICK-LOCK FRONTPLADE SÆT</p>				



Et håndslås 35/1100 1,5 og 2,0 mm	 550680 U-STOLPE ET HÅNDS 35/1100/1,5	 550681 LÅGE STOLPE VENSTRE MED ET HÅNDS HÅNDTAG 35/1100/1,5	 550682 LÅGE STOLPE HØJRE MED ET HÅNDS HÅNDTAG 35/1100/1,5	 550683 GANG STOLPE MIDT ET HÅNDS 35/1100/1,5	
	 550684 U-GANG STOLPE VENSTRE ET HÅNDS 35/1100/1,5	 550685 U-GANG STOLPE HØJRE ET HÅNDS 35/1100/1,5	 550686 GANG STOLPE VÆG HØJRE ET HÅNDS 35/1100/1,5	 550689 GANG STOLPE VÆG VENSTRE ET HÅNDS 35/1100/1,5	 550560 U-STOLPE ET HÅNDS 35/1100/2,0
	 550561 LÅGE STOLPE VENSTRE MED ET HÅNDS HÅNDTAG 35/1100/2,0	 550562 LÅGE STOLPE HØJRE MED ET HÅNDS HÅNDTAG 35/1100/2,0	 550564 U-GANG STOLPE VENSTRE ET HÅNDS 35/1100/2,0	 550565 U-GANG STOLPE HØJRE ET HÅNDS 35/1100/2,0	 550566 GANG STOLPE VÆG HØJRE ET HÅNDS 35/1100/2,0

 <p>550567 GANG STOLPE VÆG VENSTRE ET HÅNDS 35/1100/2,0</p>	 <p>550569 U-TRUG STOLPE ET HÅNDS 35/1100/2,0</p>	 <p>17374 RØRADAPTER PA F/33,7MM RØR</p>	 <p>4900490 HÅNDTAG FOR LÅGE, SÆT M/ BOLTE</p>	 <p>4950955 GULV VINKEL 133X44X39 MM A2</p>
 <p>550306 VINKEL BESLAG 36X36X65 V09</p>	 <p>34907025 SELVSKÆRENDE SKRUE Ø7X25 MM</p>	 <p>30308016 SÆTSKRUE M8X16 A2 DIN 933</p>	 <p>30308025 SÆTSKRUE M8X25 A2 DIN 933</p>	 <p>30308050 SÆTSKRUE M8X50 A2 DIN 933</p>
	 <p>30308060 SÆTSKRUE M8X60 A2 DIN 933</p>	 <p>36308055 BRÆDDEBOLT M8X55 A2 DIN 603</p>	 <p>35600058 SKÆRMSKIVE Ø8X8,4/24/2 A2 DIN9021</p>	 <p>34908061 FRANSK SKRUE M8X60 A2 DIN 571</p>
 <p>39900120 DYBEL 10X50MM</p>	 <p>1900199 U-BØJLE 1' RF M/MØTRIK</p>	 <p>4900466 SAMLESKRUESÆT 39-48 MM RF</p>	 <p>4900467 SAMLESKRUESÆT 44-58 MM RF</p>	 <p>4900468 SAMLESKRUESÆT 49-68 MM RF</p>

<p>Auto-Lock 40 mm</p>	 <p>302061 STOLPE H=100CM RUSTFRI</p>	 <p>17555 DELTASTOLPE H=83 CM</p>	 <p>550305 DELTASTOLPE 35/1030 V09</p>	 <p>70391-L LÅGE STOLPE VENSTRE 40/1010 MM MED AUTO LOCK</p>
 <p>70391-R LÅGE STOLPE HØJRE 40/1010 MM MED AUTO LOCK</p>	 <p>70392-L LÅGE STOLPE VENSTRE 40/810 M MED AUTO LOCK</p>	 <p>70392-R LÅGE STOLPE HØJRE 40/810 MM MED AUTO LOCK</p>	 <p>70390 534MM OMEGA STOLPE MIDT 40/810 MM 534 MM</p>	 <p>70390 734MM OMEGA STOLPE MIDT 40/1010 MM 7</p>
 <p>70383-L U-STOLPE VENSTRE 40/810 MM</p>	 <p>70383-R U-STOLPE HØJRE 40/810 MM</p>	 <p>70384-L U-STOLPE VENSTRE 40/1010 MM</p>	 <p>70384-R U-STOLPE HØJRE 40/1010 MM</p>	 <p>70395-L GANG STOLPE VÆG VENSTRE 40/1010 MM</p>
 <p>70395-R GANG STOLPE VÆG HØJRE 40/1010MM</p>	 <p>70397-L GANG STOLPE VÆG VENSTRE 40/810</p>	 <p>70397-R GANG STOLPE VÆG HØJRE 40/810 MM</p>	 <p>4950508 RF STABILISATOR FOR PLANKE OVER KRYBBE</p>	



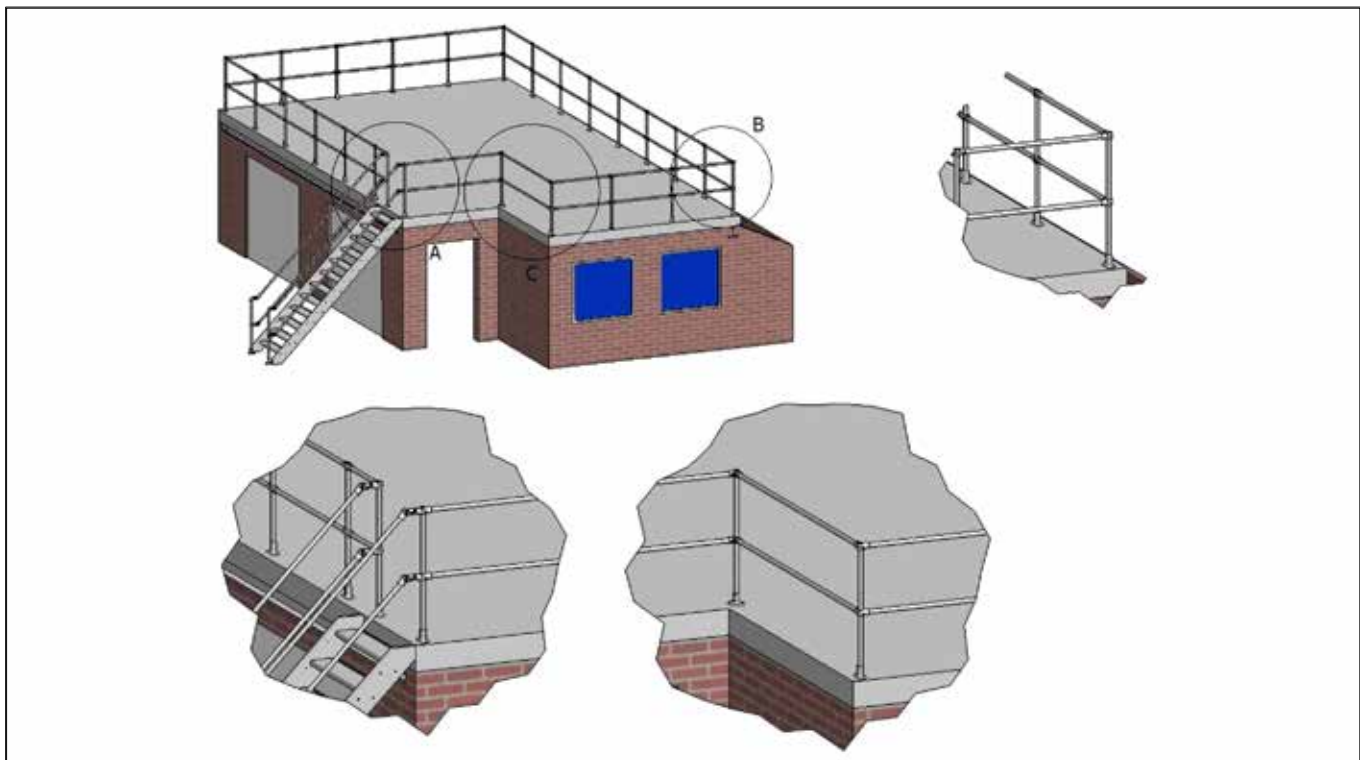



Montage sæt til Sandwich Panel	 <p>4900516 REVIT SKRUE SÆT M6</p>	 <p>4900518 REVIT SKRUE SÆT M8</p>	 <p>4900510 REVIT SKRUE SÆT M10</p>	 <p>4900915 GEVINDSTANG SÆT M10 X 150 MM</p>

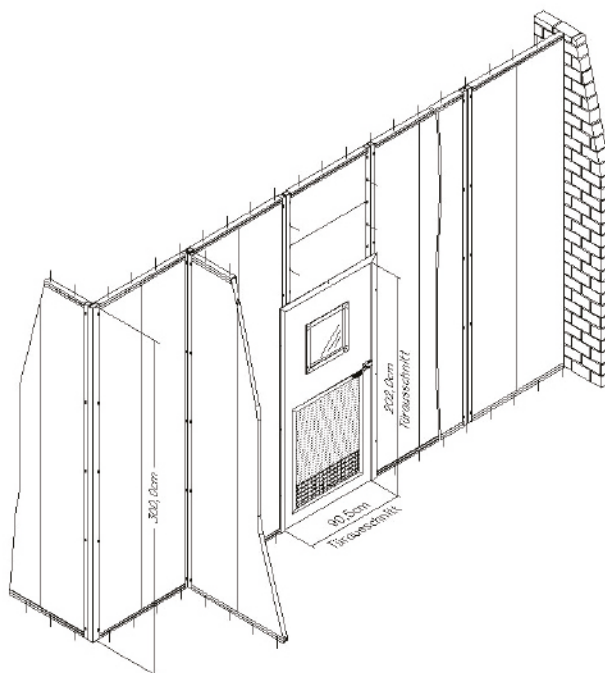



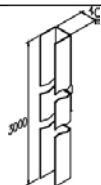

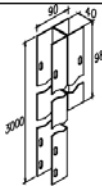



<p>Gelænderbeslag</p>	 <p>2010701 1" RØRBESLAG M/FOD, F/VÆG OG PLANKE</p>	 <p>2010702 1" RØRBESLAG 0 TIL 100 GRADER</p>	 <p>2010703 1" RØRBESLAG 90 GRADER</p>	 <p>20053 1" T-RØRBØJLE SÆT INKL. SKRUE</p>
------------------------------	--	--	--	--

 <p>94001 1" RØR GALVANISERET 6 METER UDEN GEVIND INKL. RØRSAMLING</p>
--



<p>Stalddøre</p>	 <p>17365 DØR 87,5X200CM M/VINDUE FALS H</p>	 <p>17366 DØR 87,5X200CM M/VINDUE FALS V</p>	 <p>17085 GFK VINKELSTOLPE, L=3000MM</p>	 <p>17657 U-STOLPE GLASFIBER L=3000 MM</p>
 <p>17381 VINKELSTOLPE 300 CM</p>	 <p>17408 DØR STOLPE U-PROFIL H=3000/40MM</p>	 <p>17409 H-PROFIL FOR FORLÆNGELSE H=3000/40 MM</p>	 <p>17410 KRYDSSTOLPE H=3000/40 MM</p>	

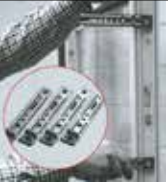

<p>Staldvinduer</p>	 <p>550600 PVC STALD VINDUE 80X60X5.8 HVID M/VIP OG SAKSE HÆNGSEL</p>	 <p>550601 PVC STALD VINDUE 100X60X5.8 HVID M/VIP OG SAKSE HÆNGSEL</p>	 <p>550602 PVC STALD VINDUE 100X70X5.8 HVID M/VIP OG SAKSE HÆNGSEL</p>	 <p>550603 PVC STALD VINDUE 100X80X5.8 HVID M/VIP OG SAKSE HÆNGSEL</p>
 <p>550604 PVC STALD VINDUE 120X80X5.8 HVID M/VIP OG SAKSE HÆNGSEL</p>	 <p>550605 PVC STALD VINDUE 125X80X5.8 HVID M/VIP OG SAKSE HÆNGSEL</p>	 <p>550606 PVC STALD VINDUE 100X90X5.8 HVID M/VIP OG SAKSE HÆNGSEL</p>	 <p>550607 PVC STALD VINDUE 100X100X5.8 HVID M/VIP OG SAKSE HÆNGSEL</p>	 <p>550608 PVC STALD VINDUE 125X100X5.8 HVID M/VIP OG SAKSE HÆNGSEL</p>
 <p>36711 MONTAGESÆT FOR KARM 4 STK.</p>				

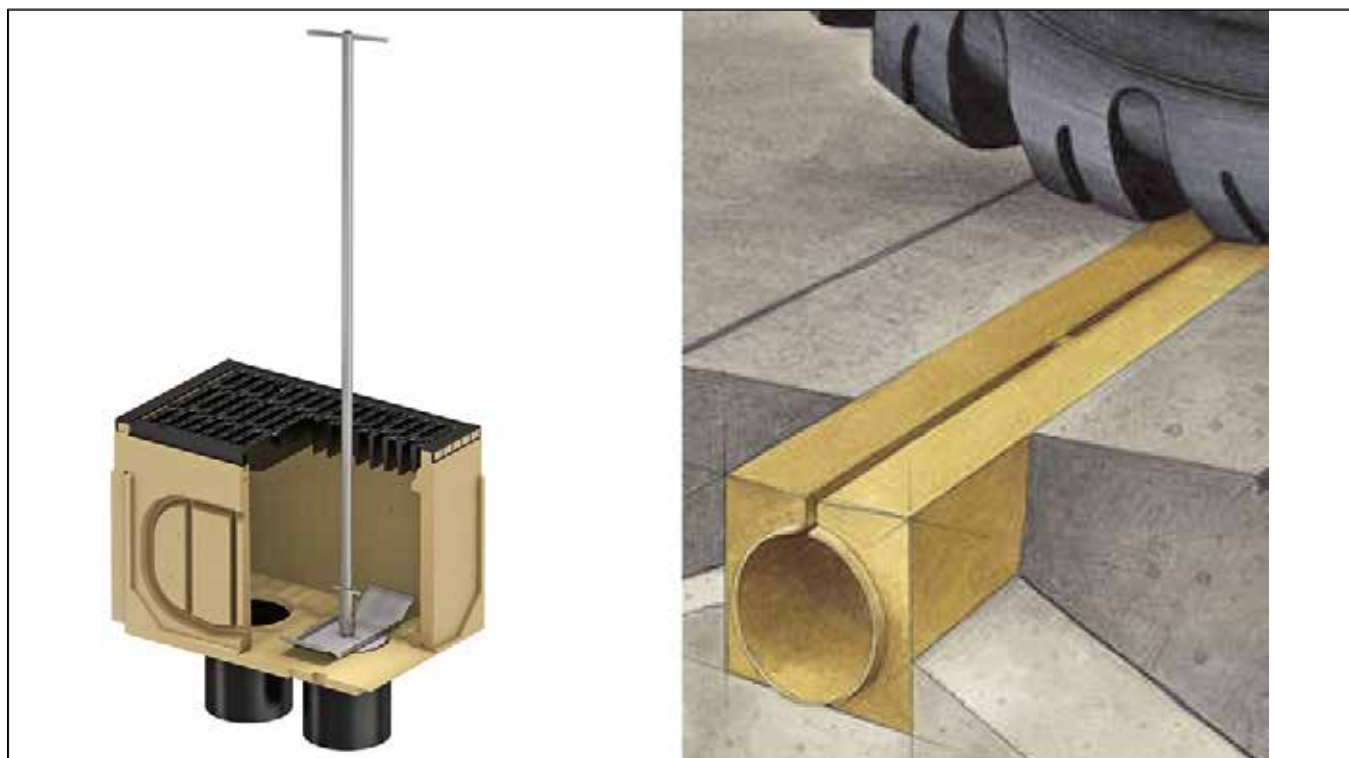

<p>Miljø- & afvandingsteknik</p>	 <p>09745 STALDRENDE LW 100, 1,00 M LANG MED STØBEJERNSAFDÆKNING</p>	 <p>09746 STALDRENDE LW 100 MED STØBEJERNSAFDÆKNING OG PVC TILSLUT</p>	 <p>09737 KOMBIENDEVÆG TIL STALDRENDE LW100</p>	 <p>09753 LÅS TIL STØBEJERNSAFDÆKNING</p>	
	 <p>09730 AFLØBSRENDE LW 100</p>	 <p>09731 AFLØBSRENDE LW 100, 1,00 M LANG MED INSPEKTIONS-DÆKSEL</p>	 <p>09732 INDLØBSKASSE 55 CM MED SPAND OG INSPEKTIONS-DÆKSEL</p>	 <p>09733 ENDESTYK M/ÅBN, AFLØBSRENDE LW</p>	<p>NOT ILLUSTRATED</p>  <p>09734 KOMBI-ENDESTYKKE TIL LW 100</p>
	 <p>18435 POLYESTER KLÆBMASSE 4 KG 150g PR. FUGE, 250g PR. SKILLERUM</p>	 <p>550670 PLASTRENDE NW100B 1,00 M LANG MED RIST</p>	 <p>550671 PLASTRENDE NW100C 1,00 M LANG MED RIST</p>	 <p>550672 KOMBI-ENDEVÆG TIL NW 100 PLASTRENDE</p>	 <p>550673 UDLØBSADAPTER TIL NW 100</p>



550675













PLASTRIST TIL NW100B 0,50
M LANG











550590











ADSKILLELSE DRÆN NW300
2 X DN160 UDLØB, 1 X PROP















INN-O-LED Plug and Play	 560760 INN-O-LED P/P 150CM/25W 4000K	 560762 INN-O-LED P/P 150CM/40W 4000KV-MODEL	 560761 INN-O-LED P/P 150CM/25W 6000K	 560764 INN-O-LED P/P 190CM/30W 6000K	
	 560763 INN-O-LED P/P 150CM/40W 6000KV-MODEL	 560770 INN-O-LED RØR P/P 150CM/25W 6000K	 560773 INN-O-LED EASY LIGHT 25W 2700K	 560776 INN-O-LED 150 CM START KABEL MED HUNSTIK	 560781 INN-O-LED Y-SPLIT P/P KABEL
	 560777 INN-O-LED 40 CM P/P KABEL	 560778 INN-O-LED 150 CM P/P KABEL	 560780 INN-O-LED 600 CM P/P KABEL	 560782 INN-O-LED ENDEPROP	











<p>INN-O-LED Plug and Play, dæmpbar</p>	 <p>560772 INN-O-LED RØR P/P 150CM/25W 6000K DÆMP- BAR</p>	 <p>560766 INN-O-LED P/P 150CM/25W 4000KDÆMPBAR</p>	 <p>560767 INN-O-LED P/P 150CM/25W 6000KDÆMPBAR</p>	
<p>INN-O-LED Plug and Play, styring</p>	 <p>0170-797 FUNKI MULTI CONTROLLER LYS MASTER</p>	 <p>0170-798 FUNKI MULTI CONTROLLER LYS SLAVE</p>	 <p>0170-790 FUNKI MULTI CONTROLLER TOM MONTAGEKASSE</p>	 <p>0170-792 FUNKI MULTI CONTROLLER TRYKKNAP MED GRØN LYS 24VDC 1 POL</p>
 <p>72111526 POWER REGULATOR LED LYS 1000/1500 W</p>				

<p>INN-O-LED Plug and Play, tilbehør</p>	 <p>560783 INN-O-LED LEDNING MONTAGE LISTE 4 METER</p>	 <p>73000640 FUNKI MULTI CONTROLLER CANBUSKABEL X 2</p>	 <p>76200023 KABELBINDER 290X4,5 SORT</p>	 <p>0153-463 MONTAGESÆT PÅ VÆG MED 4 SPÅNPLADE SKRUE</p>
 <p>560585 S-MULTIBESLAG TIL INN-O-LED</p>	 <p>8500510 HOLDER TIL INN-O-LED RØR</p>	 <p>39900102 CLAMPS-SÆT Ø38</p>	 <p>39900104 CLAMPS SÆT Ø50</p>	 <p>39900103 CLAMPS-SÆT Ø60</p>
 <p>39900105 CLAMPS SÆT Ø76</p>	 <p>0146-316 RØRBESLAGSÆT Ø38</p>	 <p>0170-504 RØRBESLAGSÆT Ø50</p>	 <p>0146-317 RØRBESLAGSÆT Ø60</p>	 <p>0170-507 RØRBESLAGSÆT Ø76</p>
 <p>60450 OPHÆNGSSÆT TIL WIRE/PIANOTRÅD</p>	 <p>02900021 PIANOTRÅD RF 2,0 MM</p>	 <p>09000024 KÆDE DACROMET GALV. PRIS PR. METER</p>	 <p>25000039 SPÅNPLADESKRUE 5X50 US TORX A2</p>	

<p>MASTER LAMP</p>	 <p>96341 MASTER LAMP 3 M KABEL, ALM.STIK</p>			
<p>FUNKI LAMP</p>	 <p>9971000 VARMELAMPE 21CM 2,5M KABEL, ALM.STIK</p>	 <p>2920509 LÅSEPLADE FOR VARME- LAMPE</p>		
<p>Tilbehør til varme- lamper</p>	 <p>2960510 LÅG FOR VARMELAMPE</p>	 <p>2900588 ADAPTER TIL VARMELAMPE INKL. SKRUER</p>	 <p>9971025 VARMEPÆRER INTERHEAT 100W KLAR KASSE A 2 STK</p>	 <p>9971027 VARMEPÆRER INTERHEAT 100W RØD KASSE A 2 STK</p>
 <p>9971020 VARMEPÆRER INTERHEAT 150W KLAR KASSE A 2 STK</p>	 <p>9971028 VARMEPÆRER INTERHEAT 150W RØD KASSE A 2 STK</p>	 <p>560596 ADAPTER SCHUKO TIL CE STIK</p>	 <p>560595 ADAPTER CE TIL SCHUKO STIK</p>	

<p>INTELLI HEAT</p>	 <p>9971016 VANDTÆT VARMELAMPE 2 M KABEL, ALM.STIK</p>	 <p>9971022 INTELLI HEAT STYRING TIL 2 STI 1,8 M FØLER, 2 FORLÆNGERLEDNING</p>	 <p>9971023 INTELLI HEAT STYRING TIL 1 STI 1,8 M FØLER, 1 FORLÆNGERLEDNING</p>	 <p>9971018 SPECIAL GLAS MED GUMMIRING</p>
 <p>9971021 RESERVEDELS POSE, FATNING MEDTILBEHØR</p>				
<p>MASTER HEATER</p>	 <p>560500 MASTER HEATER 100W UDEN STIK</p>	 <p>560502 MASTER HEATER DOBBELT KONTAKT TIL 2 MASTER HEATER</p>	 <p>560516 MASTER HEATER MULTI KONTAKT A16 TIL 18 MASTER HEATER</p>	 <p>560550 MASTER HEATER 150W UDEN STIK</p>
 <p>560510 MASTER HEATER 110V 150W UDEN STIK</p>	 <p>8440156 MASTER HEATER BORESKA-BELON</p>	 <p>4900532 MONTAGE SÆT TIL MASTER HEATER PÅ FLEXCOVER</p>		



<p>Kadavervogn</p>	 <p>99800001 KADAVERVOGN 1,85 M, TIL SØER/ORNER MAX. BELASTNING 600 KG</p>	 <p>99800002 KADAVERVOGN 1,98 M TIL SØER MAX. BELASTNING 600 KG</p>	 <p>99800003 KADAVERVOGN TIL SLAGTESVIN, MAX BELASTNING 300 KG</p>	 <p>99800004 HJUL FAST AKSEL</p>
 <p>99800005 HJUL MED SVINGGAFFEL</p>	 <p>99800006 HÅNDSPIL MED INDBYGGET BREMSE</p>	 <p>99800007 HÅNDSPIL MED 8 METER BÅND</p>	 <p>99800008 REB 6 MM, L= 430 CM, BRUDSTYKKE = 2300 KG</p>	 <p>99800009 BREMSÆT TIL AKTIVA 3002</p>
 <p>99800010 EL-HEJS TIL AKTIVA 3002</p>				



99800020
VASKEROBOT PROCLEANER
X100

Vaskerobot

ACO FUNKI A/S salgs- og leveringsbetingelser

Denne prislister er gældende pr. 1.6.2020 og erstatter alle tidligere udsendte prislister. Alle priser er bruttopriser eksklusiv moms og i øvrigt iht. følgende generelle salgs- og leveringsbetingelser.

ACO FUNKI A/S tager forbehold for trykfejl samt produkt- og prisændringer.

Nedenstående salgs- og leveringsbetingelser finder anvendelse såfremt der ikke foreligger skriftlig aftale mellem ACO FUNKI A/S og køber om fravigelser.

Tegninger og produktinformationer

Tegninger, tilbudstekst, illustrationer samt tekniske specifikationer og andre produkt informationer mv. er vejledende og uden forbindende og ACO FUNKI A/S kan ikke drages til ansvar for eventuelle fejl eller fejlfortolkninger, ej heller af bekendtgørelser, love m.m.

Projektmateriale (tegninger, illustrationer, tilbud m.m.) er ACO FUNKI A/S's ejendom, og må ikke overdrages til andre uden skriftligt tilsagn. ACO FUNKI A/S forbeholder sig ret til, hvis dette ikke overholdes, at fremsende faktura for interne omkostninger.

Tilbud

Tilbuddet er afgivet med forbehold for mellemsalg og gyldighed begrænset til det i tilbuddet anførte. ACO FUNKI A/S forbeholder sig ret til at tilbagekalde et tilbud uden varsel.

Priser

Alle priser er eksklusiv moms og baseret på de på tidspunktet for tilbuddet kendte afgifter og materiale priser. Der tages forbehold for evt. regulering af disse.

Betalingsbetingelser

8 dage netto. Køber er ikke berettiget til at modregne med eventuelle modkrav, der ikke er skriftligt anerkendt af ACO FUNKI A/S. Ved betaling efter forfald påregnes rente på 1,5% pr. påbegyndt måned. ACO FUNKI A/S forbeholder sig ret til, på et hvert tidspunkt, at kræve garantistillelse for betaling.

Ekspeditionsgebyr

Ordre modtaget under DKK 4.000 netto pålægges et ekspeditionsgebyr på DKK 150.

Leveringsbetingelser

Ab fabrik Herning iht. Incoterms 2010. (ACO FUNKI A/S har tegnet transport forsikring for alle leverancer uagtet leveringsklausul).

Leveringstid

Iht. aftale mellem køber og ACO FUNKI A/S.

Emballage

Paller og rammer faktureres til DKK 80 pr. stk. (Returnering er ikke mulig på grund af smitterisiko).

Returnering af varer

Modtages kun såfremt dette udtrykkeligt er aftalt og i så fald kun for varer ACO FUNKI A/S fremstiller som standard varer der er returneret i original emballage og ikke har været monteret eller er blevet beskadiget på nogen måde. Kreditning vil ske til 80% af varens netto pris.

Såfremt ACO FUNKI A/S har projektansvar er overskydende varer ACO FUNKI A/S ejendom.

Øvrige betingelser

Montage

Montage er ikke inkluderet i ACO FUNKI A/S's tilbud, med mindre dette udtrykkeligt er anført i ordrebekræftelsen. Det samme gælder alt el/bygningsarbejde og fundering.

Montage udføres kun efter fast pris, såfremt montagestedet er tomt, ryddet op og i klargjort stand. Det er købers ansvar at materialerne er placeret tættest muligt på montagestedet, og adgangsforholdene er acceptable efter montageafdelingens vurdering.

Ved sammenfaldende arbejde, som udføres af andre faggrupper, udføres montage efter timeløn.

ACO FUNKI A/S forbeholder sig ret til at ændre den aftalte pris for projekter med fast montagepris, såfremt montageafdelingen ikke finder montagestedet klargjort – herunder fakturering af forbrugt tid på forgæves kørsel, timeløn, oprydning, flytning af varer o.a.

Selvbærende støbejern, betonspalter, polymer krybber er aldrig inkluderet i montagepriser, undtaget hvis det fremgår specifikt af ordrebekræftelsen.

Alle vandinstallationer slutter enten ved enden af rækken eller på indvendig side af sektionen, undtaget hvis det fremgår specifikt af ordrebekræftelsen.

Ved selvmontage er alt tilpasning af udstyr på eget ansvar (rør, planker m.m.) uanset tilkøb af supervision fra ACO FUNKI A/S

Selvbærende støbejernsriste

Pga. produktionsmetoden kan der forekomme udsving i mål, og størrelse. Produktet kan derfor være uensartet.

Ingen af disse afvigelser har væsentlig betydning for produktets funktion. Støbejernsristene er kun beregnet til brug for grise og må ikke belastes på anden måde.

Generelt

Der kan generelt fremkomme farveforskelle i produkterne, specielt i produkter fremstillet af div. PVC/plast/fiber materialer.

Alle typer vandventiler er designet til et arbejdstryk på 2,5-3,0 bar. Det er købers ansvar at måle og evt. regulere vandtrykket. ACO FUNKI A/S påtager sig ikke reklamationer på vandventiler anvendt ved et arbejdstryk over 3 bar.

Ved efterforsendelse af varer/ydelse grundet påståede mangler, forbeholder ACO FUNKI A/S sig ret til fakturering af varernes værdi samt øvrige omkostninger, såfremt der tidligere er sket levering, eller der ikke er grundlag for påberåbelse af mangler.

ACO FUNKI A/S fraskriver sig reklimationsansvar såfremt der tilsættes syre i vand/foder uden forudgående accept. Ligeledes i de tilfælde hvor indeklimaet ikke opfylder normerne for godt indeklima.

Varebeskrivelsen skal kun betragtes som vejledende og kan være behæftet med fejl. Derfor er det komponentstyklisten der er gældende for tilbuddet. Hvis denne ikke er vedlagt tilbuddet, påhviler det køber at rekvirere denne.

For leverancer eksklusiv montage gælder at alle øvrige forhold reguleres iht. NL92. Dog er det aftalt at punkt 11, sidste sætning samt punkt 13 og 14 ikke finder anvendelse.

For leverancer inklusiv montage gælder at alle øvrige forhold reguleres iht. NLM94. Dog er det aftalt at punkt 45, sidste sætning samt punkt 47 og 48 ikke finder anvendelse.



STÆRKT BAGLAND

ACO FUNKI er en del af ACO Group, som er førende på markedet inden for dræningsteknologi. ACO står for professionel dræning, effektiv rengøring og en kontrolleret udledning eller genanvendelse af vand.

ACO Group bygger på omfattende research og udvikling, og teknisk ekspertise indenfor behandling af polymerbeton, plastik, støbejern, rustfrit stål, og forstærket beton.

ACO er tilstede i over 40 lande, med 30 produktionssteder fordelt på 4 kontinenter. Med 5.000 ansatte verden over, har ACO genereret salg for mere end 850 millioner Euro i 2018.

DENMARK

Kirkevænget 5
DK-7400 Herning
T. +45 97119600
F. +45 97119677
www.acofunki.dk

GERMANY

Vorwerksallee 14
24782 Büdelsdorf
T. +49 43316649711
F. +49 43314378912
info@aco-funki.de
www.aco-funki.de

FRANCE

Parc d'innovation de Mescoat
29800 Landerneau
T. +33 298 303685
F. +33 298 215506
www.acofunki.fr

SPAIN

Cr. Major 52, 1r 1a
08110 Montcada
i Reixac (Barcelona)
T. +34 935 650727
F. +34 935 753678
www.acofunki.com

RUSSIA

Kalinina str. 1
396116 Verhnyaya Hava,
Voronezh region
T. +7 915 545 44 77
www.acofunki.ru

CHINA

山东省青岛市即墨区
华山二路615号
266200
+86 0532 86657828
www.acofunki.com

UKRAINE

Shevchenka str.73
Kulykiv,
80362 Zhovka
Livi region
www.acofunki.com

POLAND

Krzysztof Skwarek
T. +48 256 83 15 98
Krzysztof.Skwarek@acofunki.com
www.acofunki.com

